

# ENGISO<sup>®</sup>

ENGINEERED SOLUTIONS

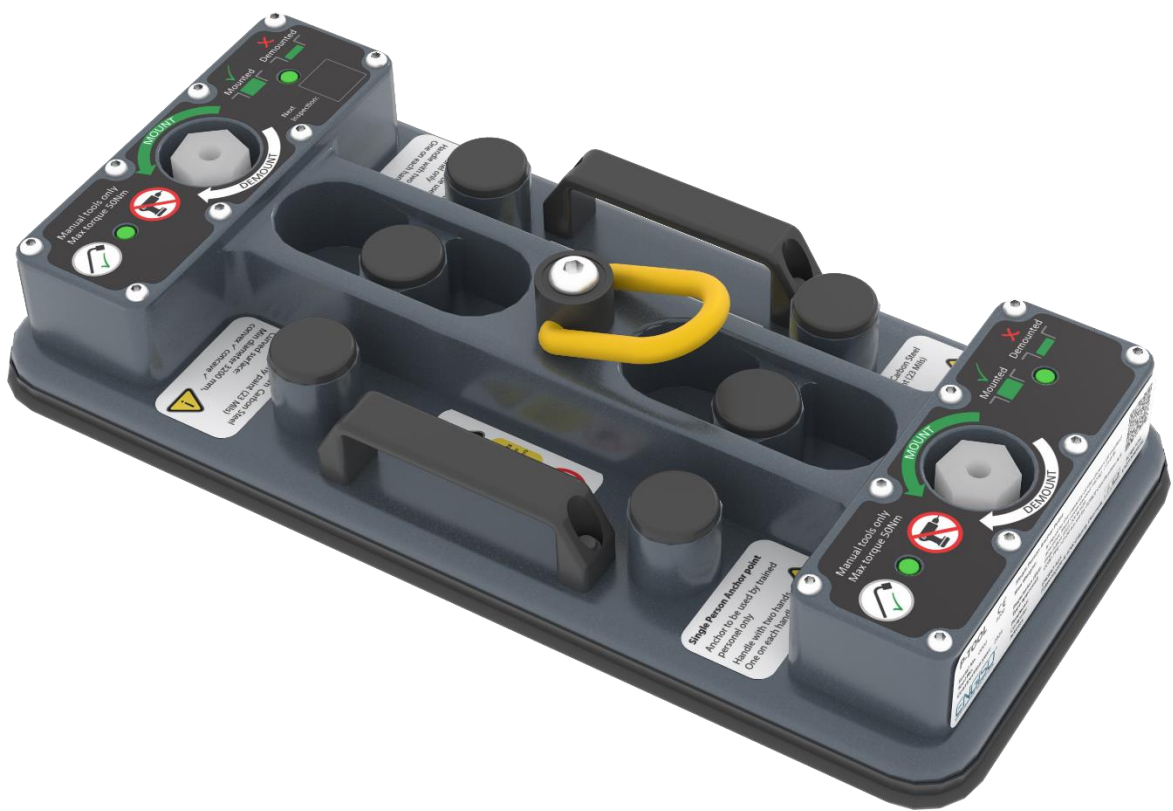

## User Instruction Manual

# The P-Tool



Video instructions

This manual is provided as the Manufacturer's Instructions, and should be used as part of an employee training program as required by relevant standards.

# CONTENT

<b>IMPORTANT INFORMATION</b>	<b>5</b>
TERMINOLOGY	6
SYSTEM REQUIREMENTS	7
<b>PRODUCT OVERVIEW</b>	<b>8</b>
PRESENTATION	8
PRODUCT SPECIFICATIONS	9
LIMITATIONS	11
<b>USING THE P-TOOL</b>	<b>12</b>
PREPARATION	12
SURFACES AND MOUNTING	14
SECURING THE P-TOOL	16
ATTACHING TO THE MAGNETIC ANCHOR POINT	18
MOUNTING EXAMPLES	19
REMOVAL AND REPOSITIONING	20
STORAGE AND TRANSPORTATION	21
TRAINING	21
<b>INSPECTION AND MAINTENANCE</b>	<b>22</b>
BEFORE EACH USE	22
PERIODIC INSPECTION	22
ANNUAL INSPECTION	22
10 YEAR INSPECTION	22
PRODUCT CARE AND CLEANING	22
AFTER A FALL ARREST	22
PRODUCT INTEGRITY	22
PRODUCT REPAIR	23
P-TOOL INSPECTION FORM	24
<b>WARRANTY AND LIABILITY</b>	<b>25</b>
LIMITED LIABILITY	25
LIABILITY FOR DEFECTS	25
LIMITATION TO LIABILITY	25
THE BUYER'S DEFAULT	26
<b>CONTACT</b>	<b>27</b>

EU  
Declaration of conformity

**Producer:**

Company: ENGISO ApS  
Address: Skolegade 85  
6700 Esbjerg  
Denmark

**- hereby state that mobile anchor point for use in relation to personal fall protection, called P-TOOL:**

Type P-TOOL  
Serie no: 0002  
Tool no: 0001 to 1000  
Construction year: 2023  
Max weight: Max weight is equal to the capacity of the chosen CE marked absorber,  
Must never exceed 140 kg. / 310 lb.  
Type Approval: 0200-PPE-12120 version 3, issued by FORCE Certification A/S

**- is in compliance with the European regulation:**

- EU REGULATION 2016/425 OF THE EUROPEAN PARLIAMENT AND OF THE COUNCIL of 9 March 2016 on personal protective equipment and repealing Council Directive 89/686/EEC.

**During the construction and certification, the standards below have been used partly not complete. For all standards selections and deselections have been made.**

- EN 795:2012

**This product is subject to compliance procedure module C2 (Production control) under the supervision of a notified body FORCE Certification A / S (0200)**

**The person below states the conformity and have the authority to collect the technical file.**

Place & Date: Esbjerg August 2023

Signature: \_\_\_\_\_

  
Allan Frikke Hansen  
Managing Director

# EU Type-Examination Certificate

## Regulation on Personal Protective Equipment (Module B) Certificate No.: 0200-PPE-12120 version 4

FORCE Certification A/S (EU-notified body number 0200) has in accordance with Regulation (EU) 2016/425 of The European Parliament and of The Council of 9 March 2016, issued EU Type-Examination Certificate to:

Manufacturer: **ENGISO ApS**

For manufacturing the following personal protective equipment:

Type/Description: **Personal fall protective equipment  
Anchor device with magnetic adherence to the substrate**

Model/Designation: **P-TOOL**

Restrictions for use: **Shall only be used on suitable substrates according to the manufacturer's instructions.  
Shall only be used together with an energy absorber according to EN 355 and/or a retractable fall arrester according to EN 360**

Category: **III**

The examined sample of personal protective equipment is found to fulfill the relevant requirements of the applied standard(s) and to be in compliance with the applicable essential health and safety requirements of Regulation (EU) 2016/425. Documentation for observance of relevant requirements and the basis for the type-examination are described in the appendix to this certificate. The manufacturer shall inform FORCE Certification A/S of any contemplated changes.

This certificate can only be used in conjunction with a valid conformity assessment procedure according to Regulation (EU) 2016/425 module C2 or D.

This version of the certificate replaces the former version 3 dated 2023-07-13 due to clarifying restrictions for use. Existing products referring to the previous version remain valid.

Date of issue [yyyy-mm-dd]: **2023-11-03**  
Date of expiry [yyyy-mm-dd]: **2027-03-03**



---

**Allan Laursen**  
Certification Manager



---

**Kasper Munk Eliassen**  
Examiner

FORCE Certification A/S task No.: **123-33336** / Certificate ID: **0200-PPE-12120-4**

The certificate is only valid with two signatures from FORCE Certification. The original version of the certificate is archived in FORCE Certification's database and is sent in electronic duplicate to the customer. The stored version of the certificate at FORCE Certification prevails as documentation for its contents and validity. This certificate will remain valid unless cancelled, revoked or expired, provided the conditions in the attached appendix are complied with, and that the equipment remains state of the art within its applicable field of service. Status of this certificate can be verified on [www.forcecertification.com](http://www.forcecertification.com). This EU Type-Examination Certificate is the property of FORCE Certification A/S. Extracts of this certificate may only be reproduced with a written permission from FORCE Certification A/S.

# IMPORTANT INFORMATION

## WARNING

This product is part of a fall arrest and fall restraint system. The following instructions must be provided to the user:

The ENGISO P-Tool is only for personal fall arrest for ONE person. DO NOT use for rigging, lifting, hoisting, rescue etc.

The ENGISO P-Tool is for ONE person only. Only one personal fall arrest system may be connected to a single ENGISO P-Tool Anchor.

The user must read and fully understand the instructions or have them explained before using the equipment.

The user must read and follow the manufacturer's instructions for each component or part of the complete system.

Manufacturer's instructions must be followed for proper use and maintenance of this product.

Alterations or misuse of this product or failure to follow instructions may result in serious injury or death.

P-TOOL is intended to be used ONLY by a person who has completed an authorized/approved course in fall protection, by any given training provider.

P-TOOL is only intended to be used along with a CE marked absorber in accordance with EN 355

This manual must be made available in local language.

## QUESTIONS

If you have any questions regarding the use, care, or suitability of this equipment for your application, please contact ENGISO.

The P-TOOL is type approved by FORCE Certification A/S 0200-PPE-12120.  
FORCE control and test random P-TOOLS every year from ENGISO (the manufacturer).





CE 0200 means that FORCE Certification will conduct a yearly inspection.



ENGISO highly advise that the user must read and understand this user manual.

## TERMINOLOGY

The following labels will be used throughout this instruction manual.

-  **NOTE:** Indicates a note or important information to help you use the product.
-  **CAUTION:** Indicates that dangerous situations might occur if used without care.
-  **WARNING:** Indicates improper use, risk of material damage, personal injury, or death.

### AUTHORIZED PERSON

A person assigned by the employer to perform duties at a location where the person will be exposed to a fall hazard (otherwise referred to as “user” for the purpose of these instructions).

### RESCUER

Person or persons other than the rescue subject acting to perform an assisted rescue by operation of a rescue system.

### CERTIFIED ANCHORAGE

An anchorage for fall arrest, fall restraint, or rescue systems that a qualified person certifies to be capable of supporting the potential fall forces that could be encountered during a fall or that meet the criteria for a certified anchorage prescribed in this standard.

### QUALIFIED PERSON

A person with a recognized degree or professional certificate and with extensive knowledge, training, and experience in the fall protection and rescue field who is capable of designing, analyzing, evaluating and specifying fall protection and rescue systems to the extent required by this standard.

### COMPETENT PERSON

One who is capable of identifying existing and predictable hazards in the surroundings or working conditions which are unsanitary, hazardous, or dangerous to employees, and who has authorization to take prompt corrective measures to eliminate them.

### INSPECTION AND MAINTENANCE LOG

The picture to the right shows the label on the P-tool. Makes it possible for the user to visually see the last inspection date before use. The full inspection data sheet is placed in this manual on page 24.

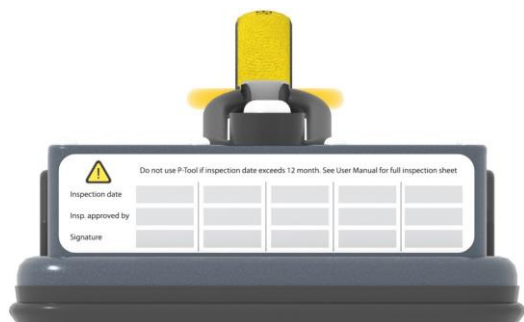

 **NOTE**

The Inspection and Maintenance Log includes:

1. Inspection Date
2. Inspection Approved by:
3. Signature

## SYSTEM REQUIREMENTS

### COMPONENTS AND SUBSYSTEMS

The ENGISO P-Tool Anchor System is designed for use with approved components and subsystems. Non-approved components or subsystems are considered incompatible with the ENGISO P-Tool Anchor System and can affect the safety and reliability of the complete system. Personal fall arrest systems must meet applicable international, local, state, and federal requirements. A full body harness including an CE-marked (EN 355) absorber must be used with this system.

Mastering these techniques requires specific training. Work with a professional to confirm your ability to perform these techniques safely and independently before attempting them unsupervised.

### COMPATIBILITY OF CONNECTORS

The ENGISO P-Tool is delivered and tested with a Yellow Yoke Swivel Hoist Ring - type 231 metric thread.

This open ring meets the following European Regulations: (EU) 2016/425 on personal protective equipment, and the applicable norms: EN1677-1

For further information: <https://www.safetyliftinggear.com/File/Download/4833>



D-Ring Swivel  
Connector

### RESTRAINT SYSTEM

Restraint systems must meet the requirements of personal fall arrest systems as stated in the section "Personal Fall Arrest System".

# PRODUCT OVERVIEW

## PRESENTATION

The Magnetic Tie Off Anchor System is intended to be used as an anchorage connector for connection of a personal fall protection system for personnel working on steel structures or other structure surfaces allowing for magnetic adhesion.

### PICTURES OF APPLICATION



Wall Mount



Working / Walking Surface Mount



Over Head Mount



## PRODUCT SPECIFICATIONS

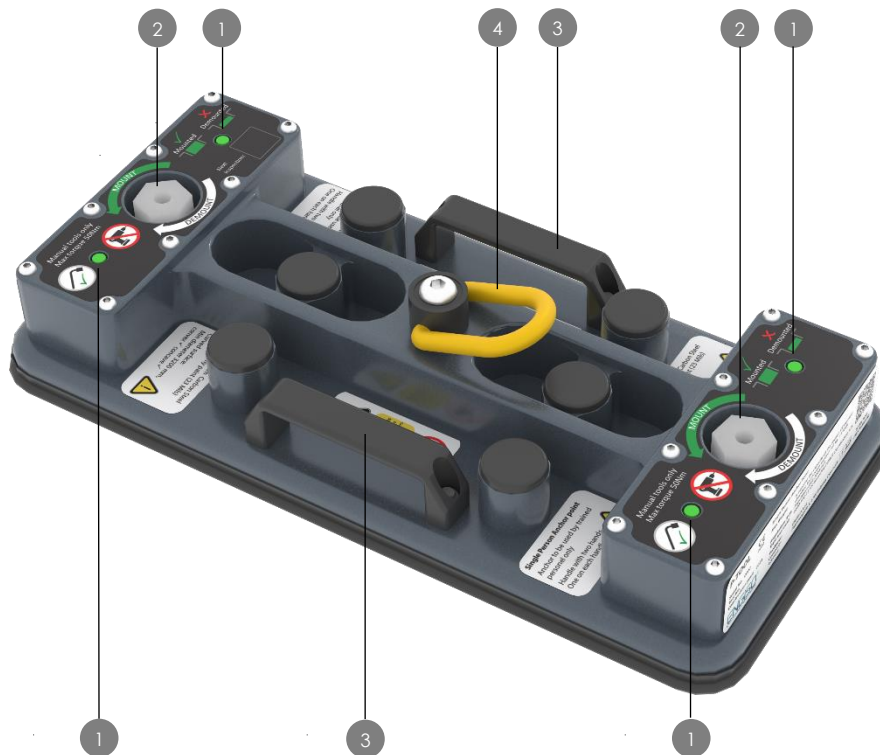

NUMBER	DESCRIPTION
1	Green Indicator Marker shows when the thrust legs are fully retracted.
2	Thrust Leg Hex Head is used to extend or retract the thrust legs.
3	The Handles are used to position the P-Tool safely with both hands.
4	The D-Ring Swivel Connector is the only place where the user lanyard is to be connected to. The D-Ring Swivel Connector will allow for free movement.

**i** NOTE

- Please contact ENGISO if you have any questions regarding use, or product suitability for your particular application.
- Never use the product with none authorized components.
- Please read through the rest of this User Instruction Manual before using the product.

# LABELING

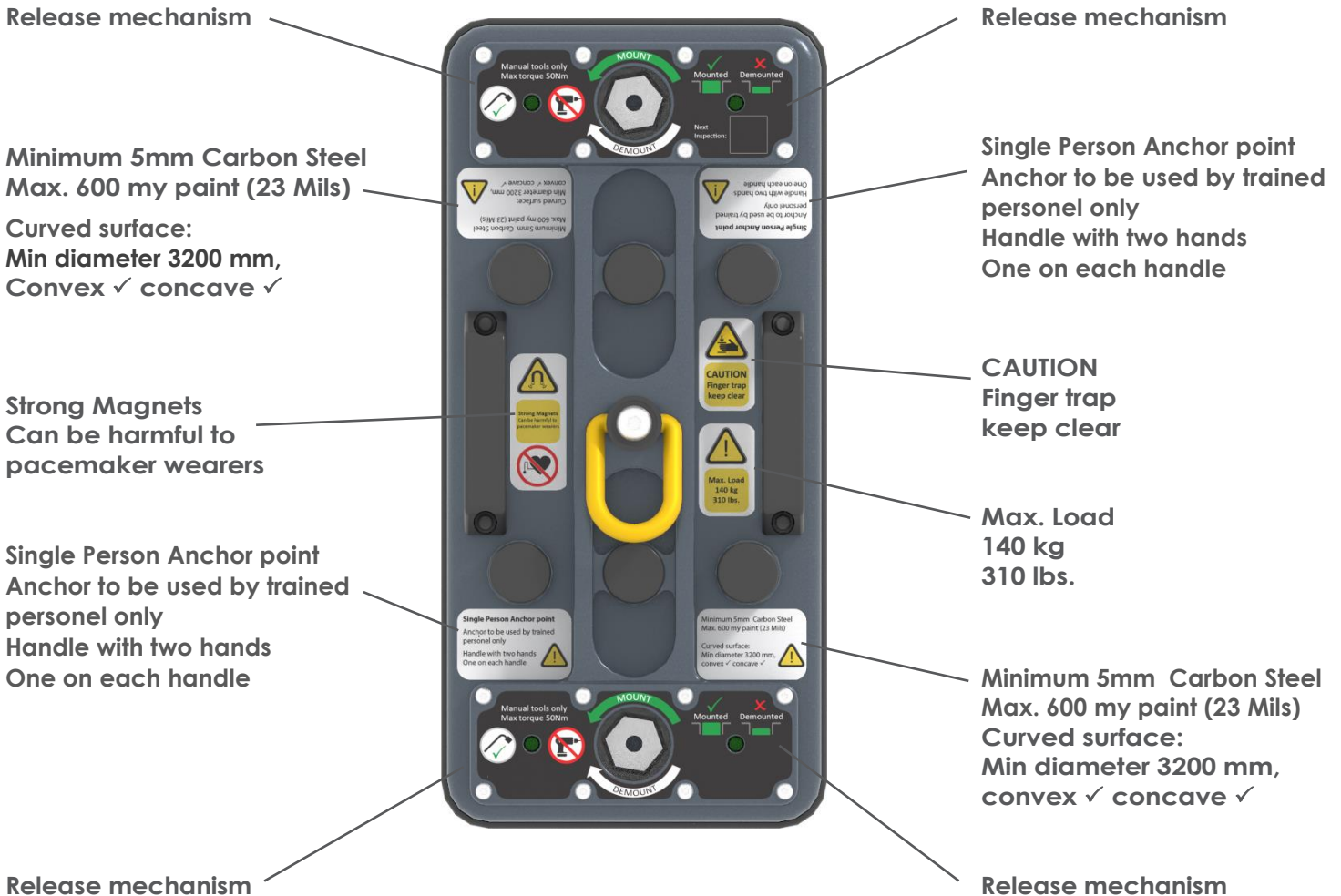

Manufacturer, buying and contact information



P-Tool Inspection Log

**CAUTION**

- Please contact ENGISO if you have any questions regarding use, or product suitability for your particular application.
- Should any of those labels be missing, do NOT use the product until inspection has been performed and such labels have been replaced by an Authorized service provider.

## LIMITATIONS

### TRAINING

This equipment is intended to be installed and used ONLY by persons trained in its application and use. Contact ENGISO for a list of Authorized Training Facilities and / or Online User Training.

### ANCHORAGE STRUCTURE

The surface to which the ENGISO P-Tool is attached must be selected according to the limitations and strength requirements specified in this manual. See sections "Surfaces and Mounting" Page 14 and "Capacity" Page 11, for more information. The structure attachment surface must be able to withstand a minimum load of 12 kN.

### PERSONAL FALL ARREST SYSTEM

Personal fall arrest systems used with the ENGISO P-Tool must be compliant with local standards. A compliant Energy Absorbing Lanyard must be used with the ENGISO P-Tool.

### PERSONAL FALL PROTECTION EQUIPMENT



#### CAUTION

- The P-Tool is only to be used along with approved CE marked personal fall protection equipment.

Engiso disclaim any responsibility if P-TOOL is used with non CE marked personal fall protection equipment

We strongly recommend that every user ensures that all their equipment is CE marked and in compliance with the relevant European Norms. These Norms can be one of the following but are not limited to these suggestions for Norms related to Personal fall protection equipment:

- EN 354 Lanyards
- EN 355 Absorber
- EN 358 Belts and lanyards for work positioning or restraint
- EN 360 Retractable type fall arresters
- EN 361 Full body harnesses
- EN 362 Connectors.

Make sure to always use the latest version of any of the given norms!!

### CAPACITY

The ENGISO P-Tool Anchor System is designed for use by a person Max weight is equal to the capacity of the chosen CE marked absorber, must never exceed 140 kg. / 310 lb.

The maximum load applied to the system and the connected component, shall not exceed 6 kN.

Only one personal fall arrest system may be connected to a single ENGISO P-Tool Anchor.

### ENVIRONMENTAL HAZARDS

Use of this equipment in hazardous environments may require additional precautions to reduce the possibility of injury to the user or damage to the equipment.

Hazards may include, but are not limited to; heat, caustic or corrosive chemicals, high voltage power lines, explosive or toxic gases, moving machinery, and sharp edges.

# USING THE P-TOOL

## PREPARATION

### WARNING

- Failure to perform this step can result in user hazard and potential death.
- Thin steel, steel grade and paint thickness affect the available connection force!
- This product is for one person only. Only one personal fall arrest system may be connected to a single ENGISO P-Tool Anchor.
- Only for personal fall arrest for one person.
- DO NOT use for rigging, lifting, hoisting, rescue etc.

### BEFORE EACH USE

Before using this product please inspect the equipment according to the section on "Inspection and Maintenance". Inspect all other protection components according to their manufacturer's instructions.

### AFTER EACH USE

After using the ENGISO P-Tool you must clean and dry the product according to the cleaning instructions in this manual and store in designated storage or transportation box.

### PLANNING

Plan your personal fall arrest system before installing and using this equipment. Consider all factors affecting your safety during use.

Always use the P-TOOL with an absorber, lanyard, and full body harness

### CAUTION

- The P-Tool is NOT a rescue tool.
- DO NOT USE the P-Tool for rescue or retrieval purposes.
- DO NOT USE the P-tool as a work positioning anchor point.
- You must always have a viable rescue plan when using this equipment.

### SYSTEM LOCATION

Establish the location of the ENGISO P-Tool Anchor System before starting your work.

IF rigging as a restraint system is not possible, position the ENGISO P-Tool Anchor such that the potential free fall is minimized by locating the ENGISO P-Tool Anchor overhead, or limiting the lanyard length and slack. It is recommended that the system is kept as short as possible. Provide safe access to and from the work location.

**⊗ WARNING**

- Do not alter or intentionally misuse this equipment.
- Consult with ENGISO when using this equipment in combination with components or subsystems other than those described in this manual. Some subsystem and component combinations may interfere with the operation of this equipment. Use caution when using this equipment around moving machinery and electrical hazards. Do not loop the lanyard around small structural members.
- Do not use this system if you are unable to tolerate the impact from a fall arrest. Age and fitness can seriously affect your ability to withstand falls. Pregnant women and minors must not use this equipment.
- Components which have been subjected to the forces of arresting a fall must be removed from service and returned to an authorized service center for inspection and repair.
- Any inspection and repair must be performed by manufacturer or authorized service center in accordance with the manufactures repair instructions, training and OEM spare parts.
- If the product has become wet, ensure the product is cleaned and dried naturally or by towel. Follow care and storage instructions in this manual.

### SWING FALLS

Swing falls occur when the anchorage point is not directly above or below the point where a fall is initialized.

The force of striking an object in a swing fall may cause serious injury or death. Minimize swing falls by working as close to the anchorage point as possible. Do not permit a swing fall if injury could occur.



Be carefull about swing falls

### SHARP EDGES

Avoid working where parts of the system will be in contact with, or abrade against unprotected sharp edges.

## SURFACES AND MOUNTING

### ⚠ WARNING

- The ENGISO P-Tool must only be used on ferrous carbon steel with a thickness of minimum 5 mm (1/4") with a maximum paint thickness of 600 my (0.6 mm).
- The structure attachment surface must be able to withstand a minimum load of 12kN.

### SURFACES FOR MOUNTING

The ENGISO P-Tool can be placed and used on a FLAT or CURVED mounting surface.

Curved surfaces are defined as a Cylindrical Concave and Cylindrical Convex with a minimum diameter of 3200 mm (126").

### ⚠ CAUTION

- IF the ENGISO P-Tool is placed on a Curved Surface, the P-Tool must be placed and installed in the direction of the cylindrical surface. The USE can be in all fall directions (360 deg.)

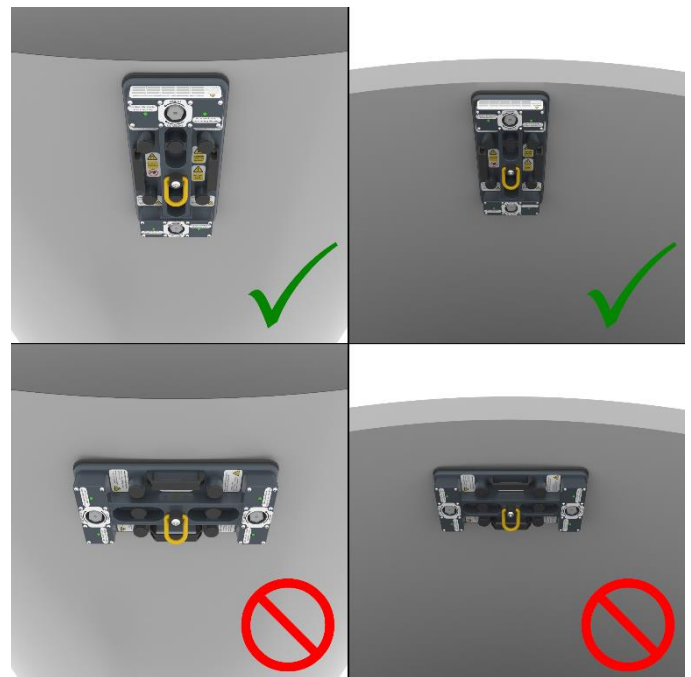
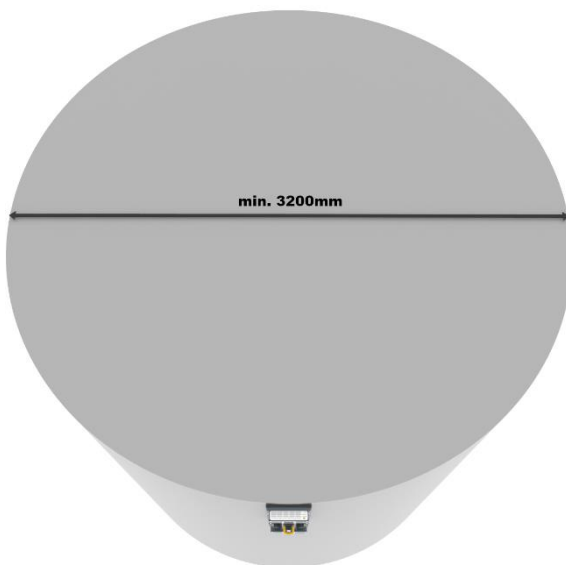

Proper mounting orientation on curved surfaces

Cylinder diametre must be minimum 3200 mm.

### i NOTE

- IF the ENGISO P-Tool is placed and installed on a Flat Surface, the P-Tool can be placed in ALL directions (360 deg.)

## STRUCTURES ON SURFACES

The magnetic adherence can be affected by the surface structures. Make sure to always to clean the

### WARNING

DO NOT attach the ENGISO P-Tool anchor to poor surface material or improperly prepared surfaces. E.g. (but not limited to):

- Structure where the magnets will not adhere properly.
- A weld seam, gaps in material etc.
- Structurally inappropriate materials or surfaces etc.
- Porous or uneven surfaces etc. that will prevent a proper adherence.
- Dirty, greasy, oiled, icy etc. surfaces that will prevent a proper adherence.
- Excessive Paint greater than 600my (0.6 mm) or Painted surfaces mixed with a non-skid medium.
- Do not attach the product on ice covered surfaces.

surface before mounting the ENGISO P-Tool.



Surface "Very Rough"

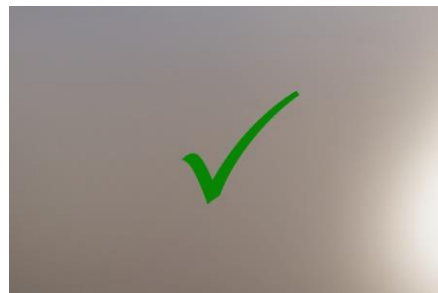

Surface "Clean and smooth"

## MOUNTING OF ENGISO P-Tool

When handling and placing the ENGISO P-Tool, use both hands (one hand on each handle) and utilize the designated handles on the P-Tool.

### CAUTION

- ENGISO P-Tool shall always be placed with the thrust legs FULLY extended.
- Placing your hands in other areas than the designated handles, can course pinch hazard.



Correct and secure hand placement



Thrust legs fully extended.

The Green Indicator marking is NOT visible when the thrust legs are fully extended. At this point the P-Tool is still fully adjustable.

**i** NOTE

- The P-Tool has sufficient pull force (Approx 10-15 kg / 22-33 Lbs) to hold its own weight during the installation and adjustment phase and can be adjusted in all directions if needed.

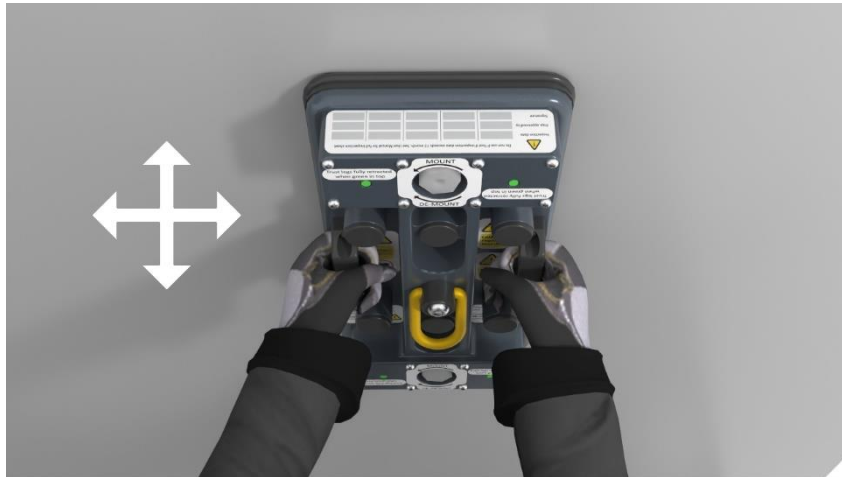

At this point the P-Tool is adjustable in all directions

## SECURING THE P-TOOL

To secure the P-Tool once it has been properly placed, utilize the socket wrench (30 mm) which is included in the P-Tool Kit.

Apply the socket wrench to the BOTTOM "Thrust Leg Hex Head" and turn, as directed, in the counter-clock "mounting" direction.

**i** NOTE

- Turn the wrench in the "mounting" direction until the Green Marker appears in the viewing indicator hole and is flush with the P-Tool surface. The bottom should now be fully engaged.



Worker mounting the P-Tool



The bottom in fully engaged



Apply the socket wrench to the TOP "Thrust Leg Hex Head" and turn, as directed, in the counter-clock "mounting" direction.

**i** NOTE

- Turn the wrench in the "mounting" direction until the Green Marker appears in the viewing indicator hole and is flush with the P-Tool surface. The top should now be fully engaged.



Worker mounting the P-Tool



The top in fully engaged

**x** WARNING

- Check that all four (4) Green Indicator markings are visible, fully extended and completely flush with the P-Tool top surface.
- FAILURE to perform this step can result in user hazard and potential death.

The Four (4) GREEN indicators in top position, only indicate that all thrust legs are fully retracted, and the magnets are now engaged with the mounting surface.

All other conditions listed in this User Instruction Manual MUST be followed for full functionality.



Green Indicators are flush with the top surface



The P-Tool is securely attached

The ENGISO P-Tool Anchor System is now ready for attachment of your personal fall arrest lanyard system.

## ATTACHING TO THE MAGNETIC ANCHOR POINT

Attach your fall protection system lanyard to the Yellow Connector Ring at the end of the ENGISO P-Tool as shown below.



Parallel attachment (not allowed)



Attachment directly to Handle (not allowed)



Correct attachment to Yellow Connector Ring

**×** WARNING

- Any parallel attachments are strictly prohibited.
- Attaching directly to the handle is strictly prohibited.
- FAILURE to attach correctly can result in user hazard and potential death.

See personal fall arrest system manufacturer's instructions for connecting subsystems used with the ENGISO P-Tool Anchor System.

## MOUNTING EXAMPLES

### WALL MOUNTED ENGISO P-TOOL

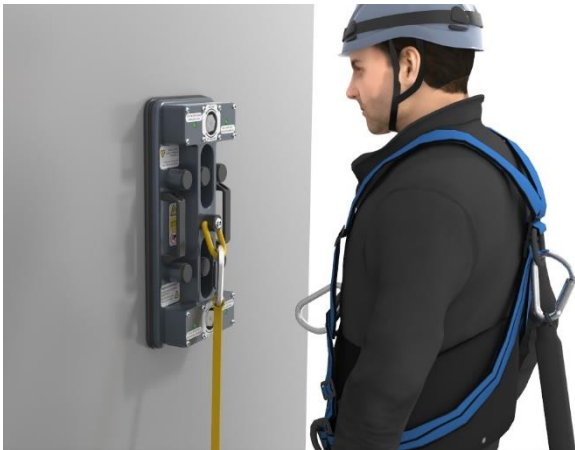

P-Tool mounted to wall



P-Tool mounted to wall with operator attached

### OVERHEAD MOUNTED ENGISO P-TOOL

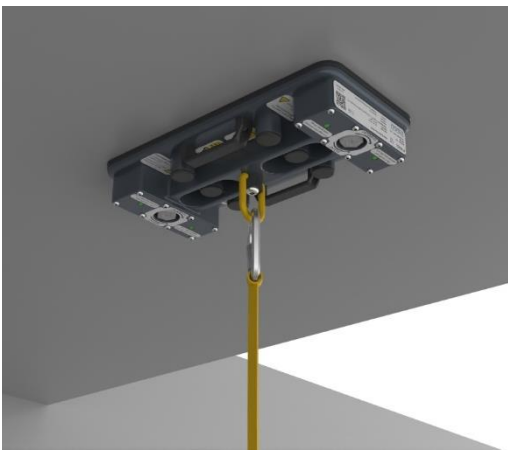

P-Tool mounted to overhead ceiling



P-Tool mounted to ceiling with operator attached

WALKING / WORKING MOUNTED ENGISO P-TOOL

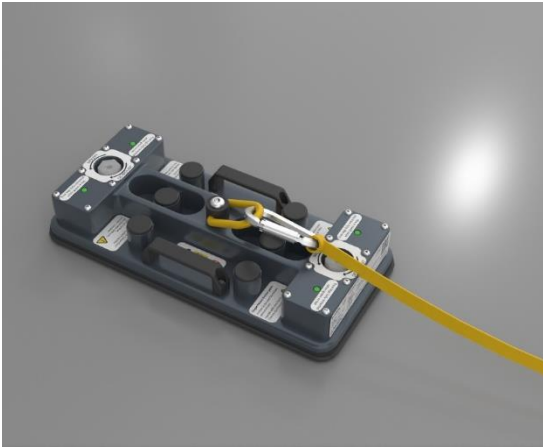

P-Tool mounted to floor / walking area



P-Tool mounted to floor with operator attached

## REMOVAL AND REPOSITIONING

**i** NOTE

- Turn the wrench in the "de-mount" direction. Keep turning until the thrust legs are fully extended, do not use excessive force. Repeat for both Thrust Leg Hex Head's.
- Approximately Eight full turns per Hex Head.



Release both Thrust Leg Hex Head's



At this point the P-Tool can be adjusted in all directions

To remove or reposition ENGISO P-Tool Anchor, turn the Thrust Leg Hex Head in the "De-mount" until the legs are fully extended, do not use excessive force. Remove or reposition the ENGISO P-Tool Anchor to a new location and repeat the installation instructions found in the section "Mounting of ENGISO P-Tool".

## STORAGE AND TRANSPORTATION

The product must be secured in the dedicated transport / storage box. The product must be stored in a dry location, out of direct sunlight and at room temperature.

## TRAINING

The user and purchaser of this equipment must be familiar with the instructions, operating characteristics, application limits, and the consequences of improper or misuse of this equipment. Users and purchasers must be trained prior to use in the correct care and use of this equipment.

P-TOOL is intended to be used **ONLY** by a person who has completed an authorized/approved course in fall protection, by any given training provider.

### WARNING

- Training must be conducted without exposing the trainee to fall hazards.
- Training should be repeated on a periodic basis, minimum annually or as per local requirements.

# INSPECTION AND MAINTENANCE

ENGISO P-Tool anchor inspection procedures. See "Product Specification" and "Labeling" for more information on locations and parts identification. The product integrity is dependent on periodic inspection and proper maintenance.

## BEFORE EACH USE

1. Inspect the ENGISO P-Tool Anchor System for damaged and loose or missing parts.
2. Inspect the EPDM rubber around the Magnets for wear or damage. Inspect the underside of the P-Tool.
3. Wipe off any debris collected on the Magnetic Surface(s).
4. Test the functionality of the Thrust Bolts.
5. Do not use the ENGISO P-Tool Anchor System if any part fails inspection.

## PERIODIC INSPECTION

1. Monthly and Country Specific periodic inspections may be replaced by performing the following inspection of the P-Tool Anchor System before or after each use.
2. Inspect all V-MAGs for wear, and heat or chemical related damage.
3. Inspect the P-Tool for wear, crushing, and heat or related chemical damage.
4. All labels must be present and fully legible.
5. Inspect the V-MAGs for cuts, burns, weather checking, and torn or damaged sealing lips.
6. Check for loose or missing fasteners.
7. Test the functionality of the Thrust Bolts.
8. Do not use the ENGISO P-Tool Anchor System if any part fails inspection.
9. Always mark the P-Tool inspection log with the Inspection Date, Test Approved by and Signature.

## ANNUAL INSPECTION

1. Annual inspection is defined as minimum every 12 month.
2. Annually, the ENGISO P-Tool Anchor must be inspected by an ENGISO authorized; training provider, service provider and service technician.
3. Please contact ENGISO to locate for your nearest authorized training and service provider.
4. Always mark the P-Tool inspection log with the Inspection Date, Test Approved by and Signature.

## 10 YEAR INSPECTION

1. 10 years from the date of purchase we recommend that the P-Tool is handed in to the manufacturer, or a representative for the manufacturer, for test and inspection.

## PRODUCT CARE AND CLEANING

1. The product must always be stored and transported in the designated storage / transport box.
2. Cleaning the product should be done in luke warm water using a mild cleaning agent e.g. dish washing soap.
3. After cleaning the product must be left to dry naturally by air or by using a towel.

## AFTER A FALL ARREST

1. Components which have been subjected to the forces of arresting a fall must be removed from service and returned to an authorized service center for inspection and repair.

## PRODUCT INTEGRITY

1. If the product has been dropped, damaged or if you are in doubt about the product integrity. The equipment must be removed from service and inspected by a competent person.
2. The product must only be placed back into service after a written and signed inspection form.

## PRODUCT REPAIR

1. Any inspection and repair must be performed by manufacturer or authorized service center in accordance with manufactures repair instructions, training and OEM spare parts.

The P-Tool Inspection Tool can be found on the next page.





# WARRANTY AND LIABILITY

## LIMITED LIABILITY

### 1 LIABILITY FOR DEFECTS

- 1.1 The Seller undertakes to remedy defects which are due to defects in manufacturing or defects in the product if it can be proved that the defect can be referred to the Seller. The Seller may remedy such defect by repair at the Seller's address or by delivering new equipment at the Seller's option. The Buyer shall have no other remedies for breach.
- 1.2 The product can only be returned according to prior agreement with the Seller.
- 1.3 Apart from warranties made, the Seller's liability shall only include defects which appear within one year from the date on which the product was delivered. If the product is used more intensively than foreseen in the agreement between the Parties, such period shall be reduced proportionally.
- 1.4 If a defect is to be claimed towards the Seller, the Buyer shall complain in writing to the Seller, just as the Seller shall only be liable for the defect if the complaint is made without undue delay after the occurrence of the defect.
- 1.5 Parts replaced or repaired as stated in item 1.1, shall be covered by a new liability period of one year.
- 1.6 Regardless of item 1.5, the Seller's liability for defects shall not exceed two years for any part of the equipment, regardless of the date of delivery.
- 1.7 Remedying through repair according to item 1.1 shall be carried out by the Seller, and the Buyer shall therefore carry out demounting and remounting at his own expense, just as the Buyer shall cover all costs of freight and transport in connection with the repair.
- 1.8 For remedying through delivery of new equipment according to item 1.1 the Buyer shall cover all costs of demounting and remounting, just as the Buyer shall be obliged to cover all costs of returning the defective product to the Seller.
- 1.9 If demounting and remounting leads to interference with, damage to equipment belonging to the Buyer or a third party, etc., all costs and work in this connection shall be covered by the Buyer only. With reference to the damage caused by such interference, the Seller shall be entitled to refuse to demount or remount and this shall not increase the liability of the Seller.
- 1.10 The Seller's liability for defects shall not include defects caused by equipment obtained by the Buyer or a third party, the Buyer's incorrect use of the product, or the Buyer's use of the product in other conditions than those assumed in the agreement.
- 1.11 Defects which have occurred after transfer of the risk to the Buyer, including defects caused by lack of maintenance or lack of proper maintenance, incorrect mounting, the use of unoriginal parts, repairs carried out by the Buyer, etc., shall be irrelevant to the Seller, unless the Seller has given his prior consent to the activities of the Buyer.
- 1.12 If the Buyer complains about a defect and it turns out during the repair that there is no defect for which the Seller is liable, the Seller shall be entitled to compensation for the work and the costs incurred by the Seller through such complaint.

### 2 LIMITATION TO LIABILITY

- 2.1 The Seller shall not be liable for lost profit, operating loss or other indirect losses which occur as a consequence of delay or defects in the product, just as claims for compensation towards the Seller shall never exceed the invoice amount for the equipment sold.
- 2.2 The Seller shall not be liable for claims made against the Buyer by a third party which relates to the Buyer's use of the products in violation of third party rights.

**3 THE BUYER'S DEFAULT**

- 3.1 If the Buyer fails to make due payments, cf. item 5, or otherwise ignores the stipulations in the present agreement, the Seller shall be entitled to cancel the order in question in its entirety and to claim compensation for any related loss.
- 3.2 The customer shall only be entitled to set off an amount against the purchase amount with the Seller's prior written consent.



#### **ENGISO Europe**

Fiskebrogade 8, 6700 Esbjerg,  
Denmark  
(+45) 70 23 00 75  
info@engiso.dk

#### **ENGISO North America**

Springboro, Ohio, USA  
(+1) 414 331 1345  
americas@engiso.com

#### **ENGISO APAC**

Changping District, 102202 Beijing, China  
apac@engiso.com

#### **ENGISO MENA**

Abu Dhabi, UAE  
(+45) 70 23 00 75  
emea@engiso.com

## **CONTACT**

How can we best help your company in regards to consulting services, turnkey solutions or our proven product line?

Feel free to contact us by either phone or email. We are looking forward to hearing from you.